

Public–Key Identification Schemes based on Multivariate Quadratic Polynomials

Koichi Sakumoto, Taizo Shirai, Harunaga Hiwatari
from Tokyo, Japan

Sony Corporation

@CRYPTO2011

Motivation

- Finding a new alternative to current standard schemes (e.g., RSA) for public-key identification and digital signature

Especially, we would like to provide an alternative based on a problem other than Factoring or DL

Prior works are based on

- Permuted Kernel problem [Shamir '89]
- Syndrome Decoding problem [Stern '93]
- Lattice problem [Micciancio and Vadhan '03]
- ...

➔ We focus on an MQ problem



What is an MQ problem?

- Solving a Multivariate Quadratic equation system over a finite field

Given: coefficient a_{lij} , b_{li} , y_l
Find: a solution (x_1, \dots, x_n)

$F(x_1, \dots, x_n) = \left\{ \begin{array}{l} \sum_{ij} a_{1ij} x_i x_j + \sum_i b_{1i} x_i = y_1 \\ \vdots \\ \sum_{ij} a_{mij} x_i x_j + \sum_i b_{mi} x_i = y_m \end{array} \right.$

“MQ function”

Advantage

- The MQ function can be efficiently implemented
- The MQ function can be used as a one-way function with very short output (e.g., 80 bits)
 - The intractability of a random instance has been well examined
- Associated decision version of the MQ problem is NP-complete
 - There is no known polynomial-time quantum algorithm to solve it

Multivariate Public Key Cryptography (MPKC) uses this form of functions.
But, many existing schemes of MPKC have been already shown to be insecure. Why?

Existing design of Multivariate PKC

- Based on a trapdoor function from composition of easily invertible maps
 - MI scheme [Matsumoto and Imai '88], HFE scheme [Patarin '96], UOV scheme [Kipnis, Patarin, and Goubin '99]

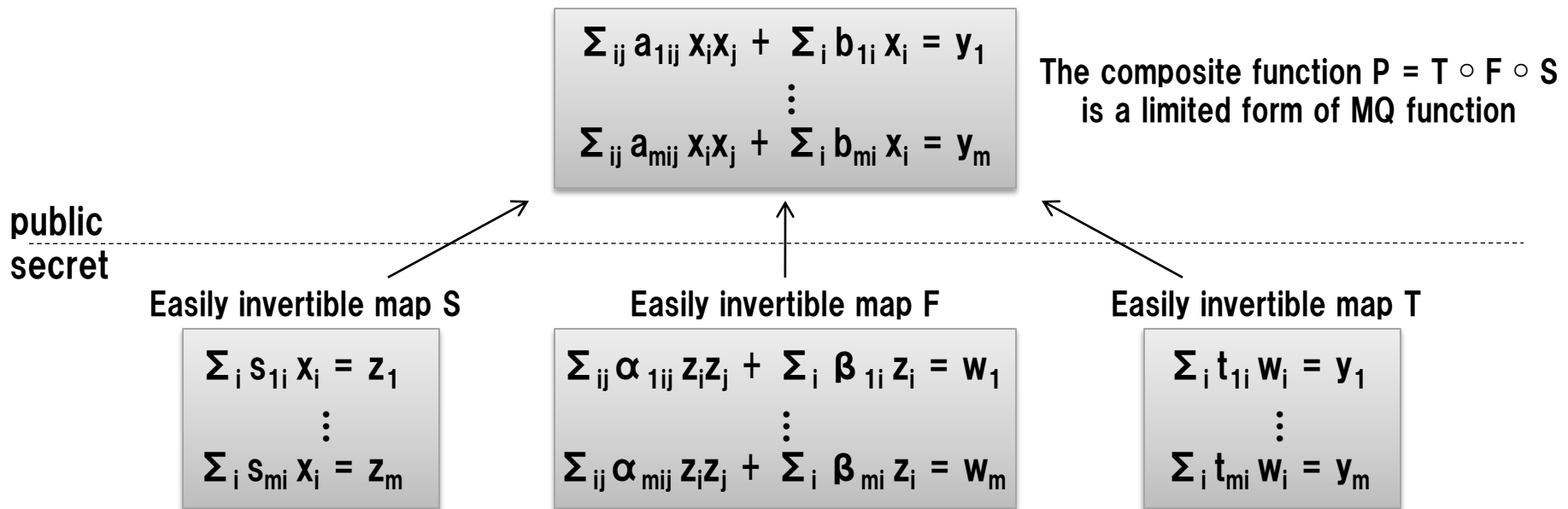

- The key recovery problem is not an MQ problem, but another problem whose intractability is still controversial**
 - The problem is called Isomorphism of Polynomials (IP) problem

In fact, some schemes of MPKC have been already shown to be insecure

Our design

- Based on a zero knowledge argument of knowledge for the MQ problem
 - Especially, a non-trivial and efficient construction by using our original technique

Note: It uses not a composite function, but a random instance of MQ function

System parameter: coefficient a_{lij} , b_{li}

Secret key: input (x_1, \dots, x_n)

Public key: output (y_1, \dots, y_n)

$$\sum_{ij} a_{1ij} x_i x_j + \sum_i b_{1i} x_i = y_1 \text{ public key}$$

⋮

$$\sum_{ij} a_{mij} x_i x_j + \sum_i b_{mi} x_i = y_m$$

commonly used by all users

Advantage

- The key recovery problem is an MQ problem
 - The security of our scheme can be reduced into the intractability of the MQ problem
- The size of a public key is very small (e.g., 80 bits)

Summary of introduction

- MQ problem is intractable and promising
- We introduce a different design than existing MPKC

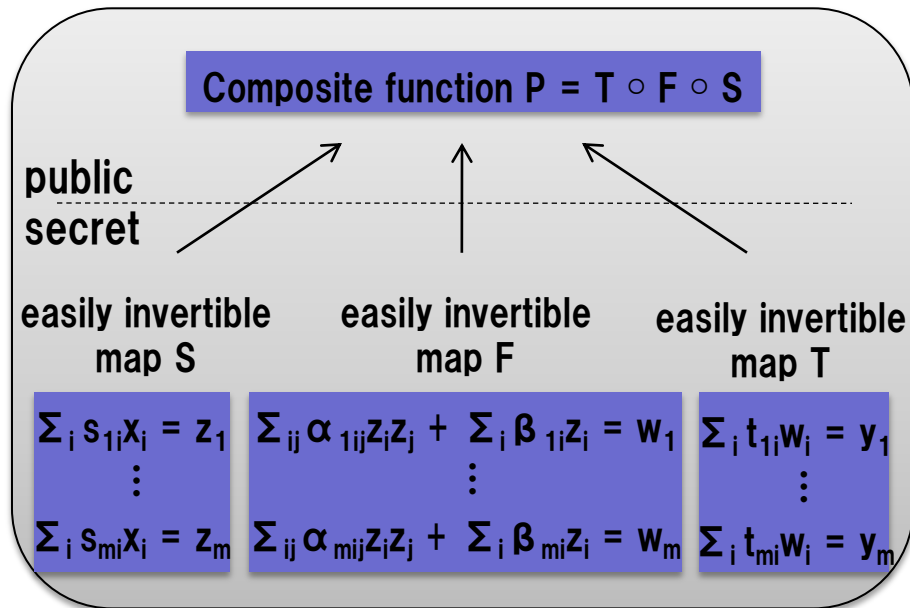

Existing design of MPKC

Based on a trapdoor function
from composition of easily
invertible maps

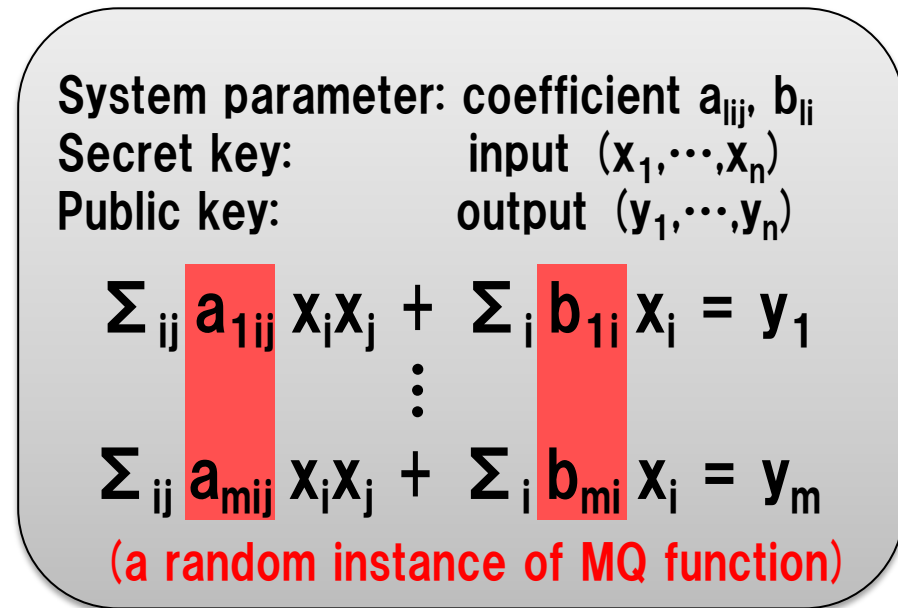

Our design

Based on a zero knowledge
argument of knowledge for the
MQ problem

Outline

- **Introduction**
 - **Motivation**
 - **What is an MQ problem**
 - **Existing design of MPKC**
 - **Our design**
- **New technique and construction**
 - **Zero knowledge argument of knowledge**
 - **Cut and Choose**
 - **New technique using the polar form of MQ function**
 - **Basic protocol**
 - **Public-key identification scheme**
 - **Efficiency**
- **Summary**

Outline

- **Introduction**
 - Motivation
 - What is an MQ problem
 - Existing design of MPKC
 - Our design
- **New technique and construction**
 - Zero knowledge argument of knowledge
 - Cut and Choose
 - New technique using the polar form of MQ function
 - Basic protocol
 - Public-key identification scheme
 - Efficiency
- **Summary**

Zero knowledge argument of knowledge

- Alice (Prover) asserts that she has a solution of the MQ problem
- Bob (Verifier) checks whether the assertion is true or not through interaction with Alice

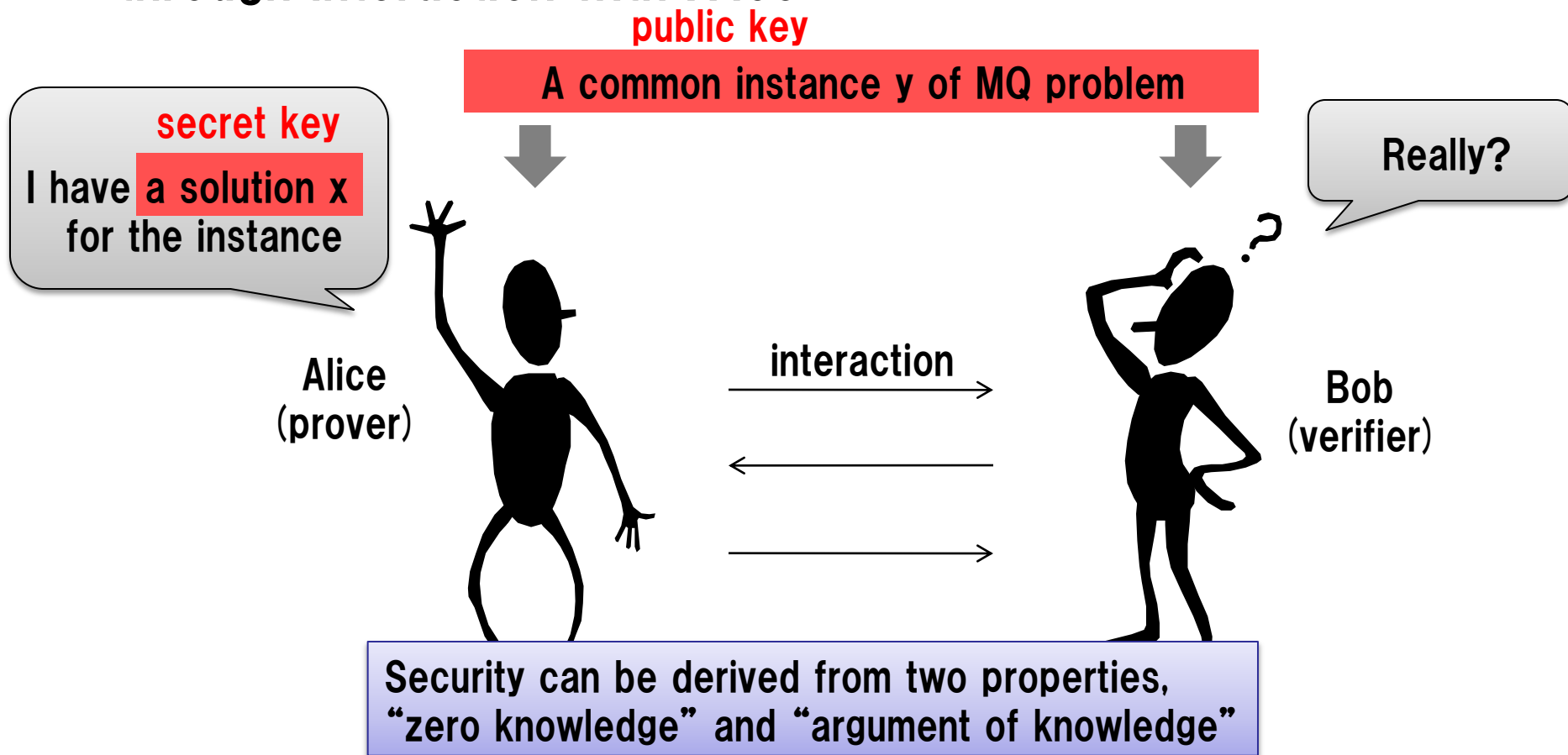

Cut-and-Choose approach

1. Alice (prover) divides her secret into shares
2. Bob (verifier) chooses which share he checks
3. She proves the correctness of the chosen share without revealing her secret itself

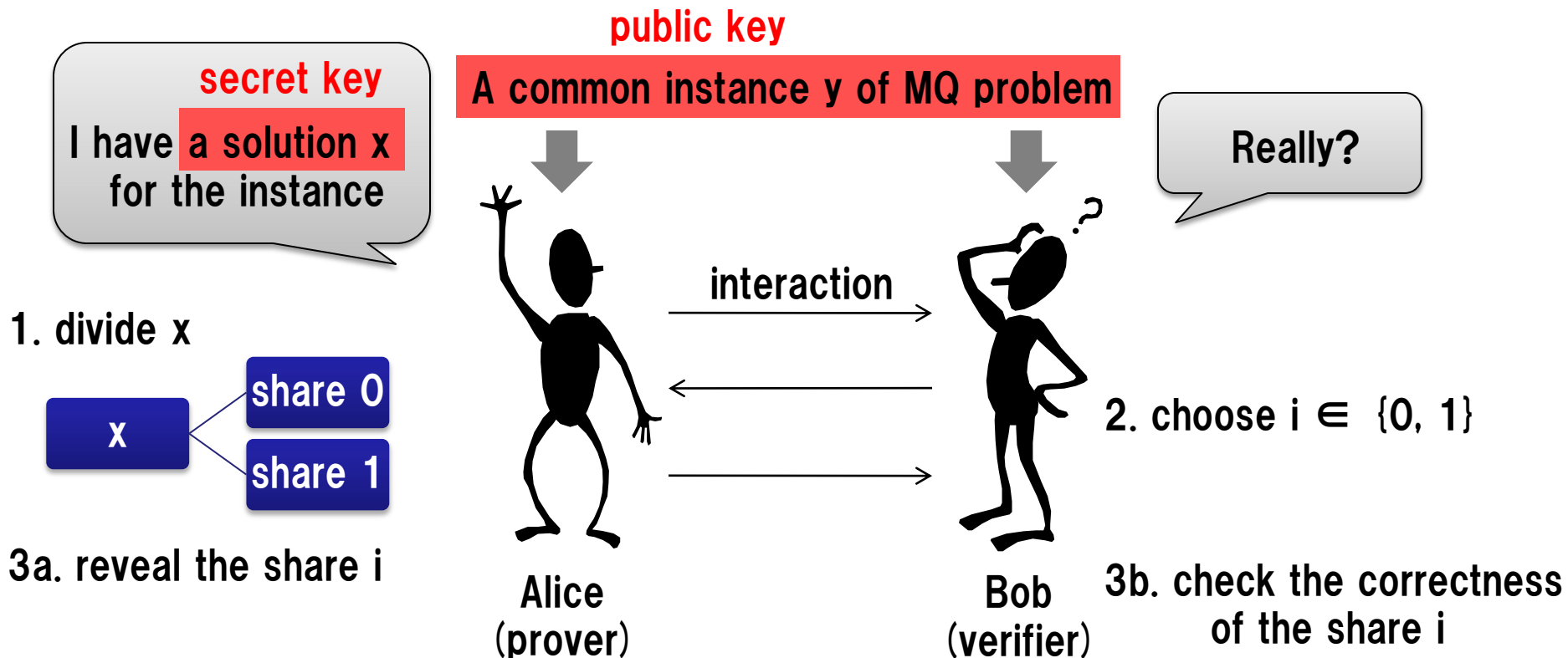

Cut-and-Choose approach

1. Alice (prover) divides her secret into shares
2. Bob (verifier) chooses which share he checks
3. She proves the correctness of the chosen share without revealing her secret itself

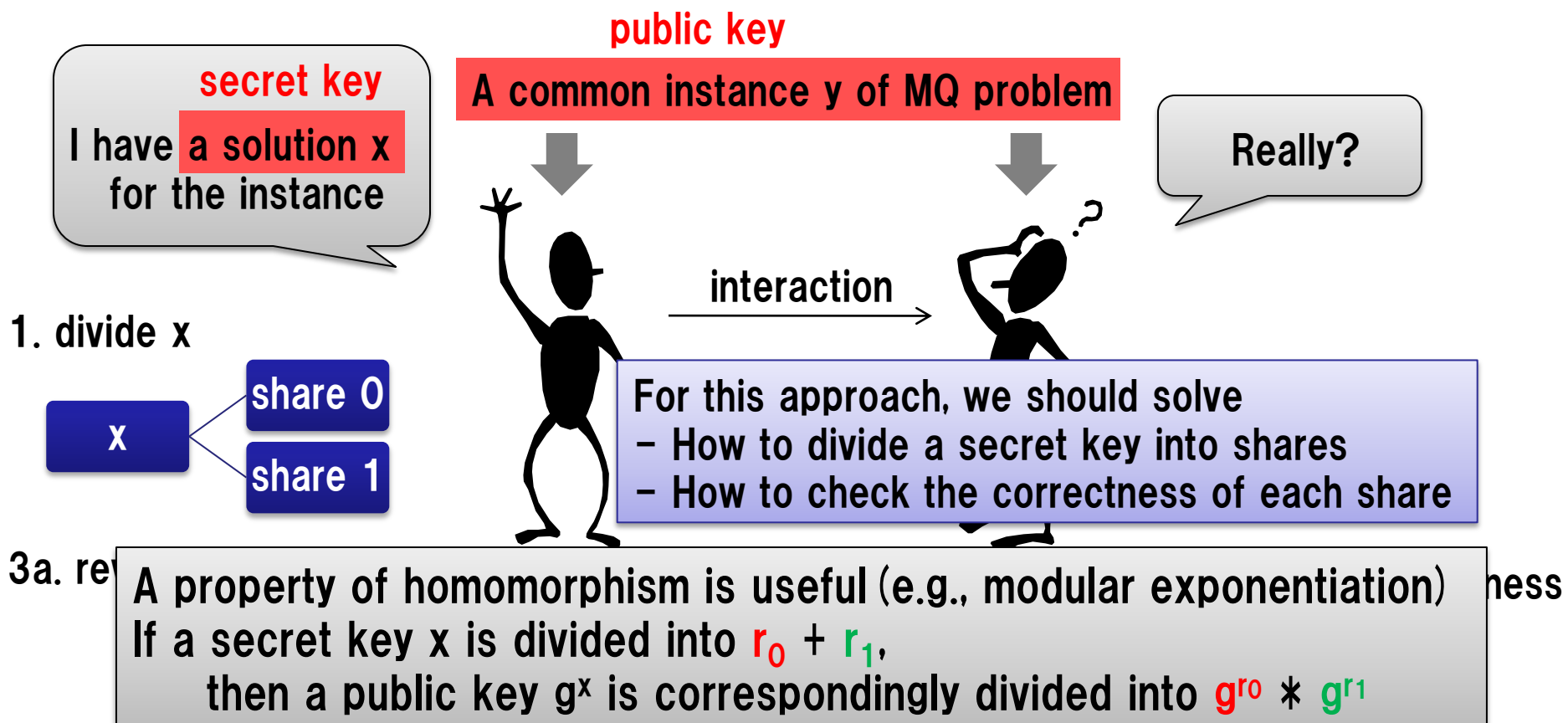

New Cut-and-Choose technique

For an MQ function F , consider a situation where

- Secret key: x
- Public key: $y = F(x)$

A useful property

The associated polar form $G(x,y)$ of $F(x)$
 $G(x,y) = F(x+y) - F(x) - F(y)$
is a **bilinear** function

By using the useful property, divide a secret key into three shares:

- First, divide $x = r_0 + r_1$
 - Consequently, y is divided $y = F(r_0+r_1) = G(r_0,r_1) + F(r_0) + F(r_1)$
- Second, further divide $r_0 = t_0 + t_1$ and $F(r_0) = e_0 + e_1$
 - Consequently, $y = \underbrace{G(t_0,r_1) + e_0}_{\text{share0 and share2}} + \underbrace{F(r_1) + G(t_1,r_1) + e_1}_{\text{share1 and share2}}$

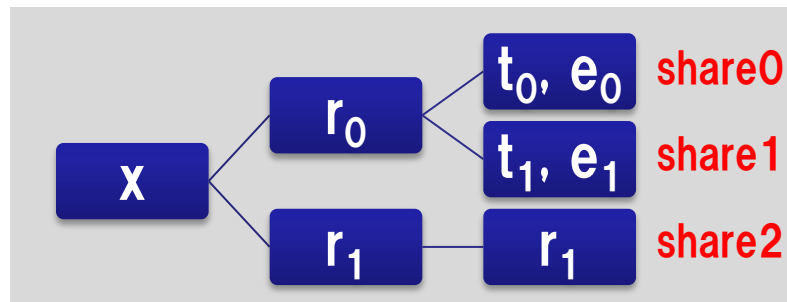

Note

No information on the secret key x can be extracted from only two out of the three shares

Our basic protocol

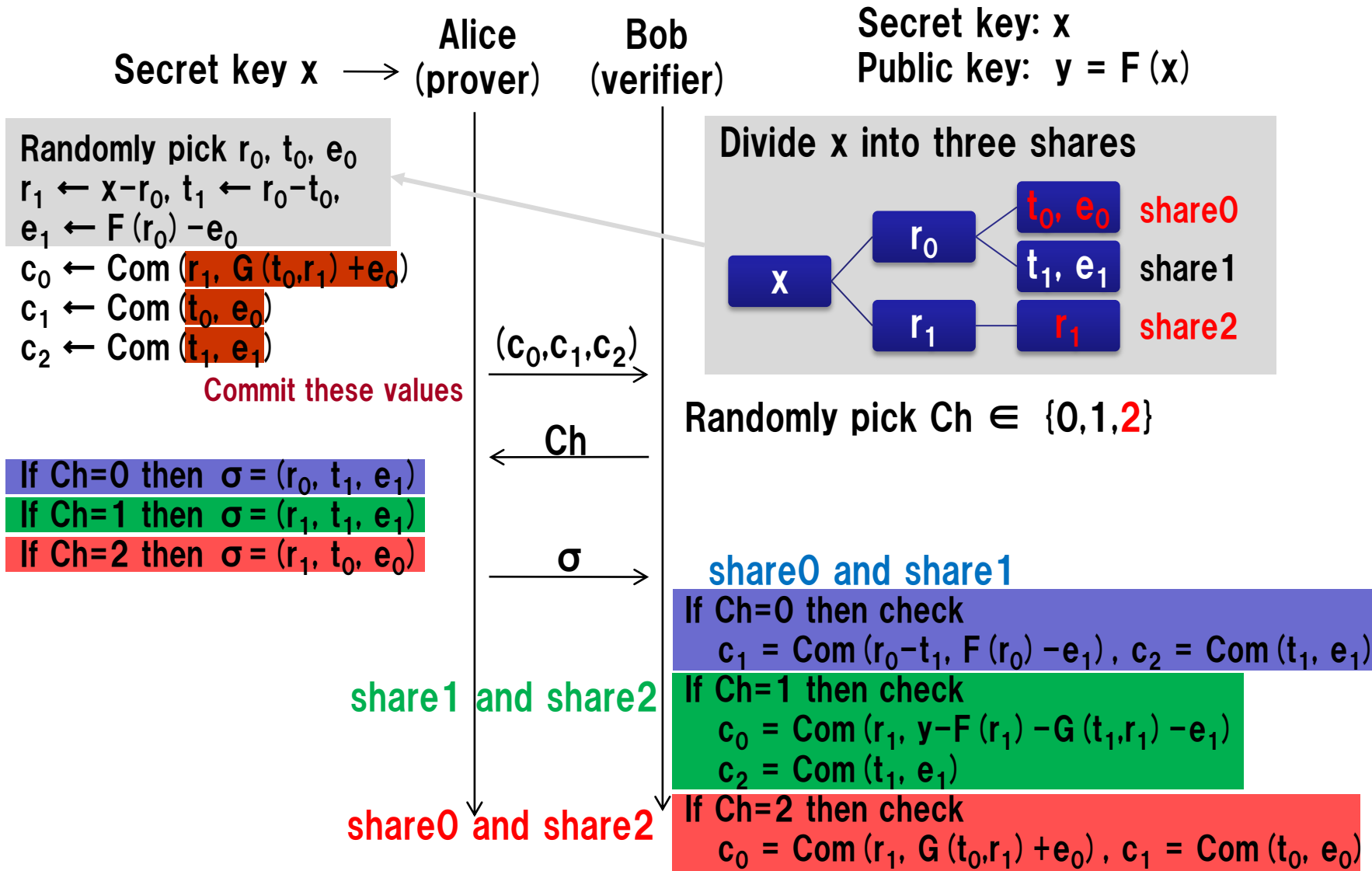

Our basic protocol

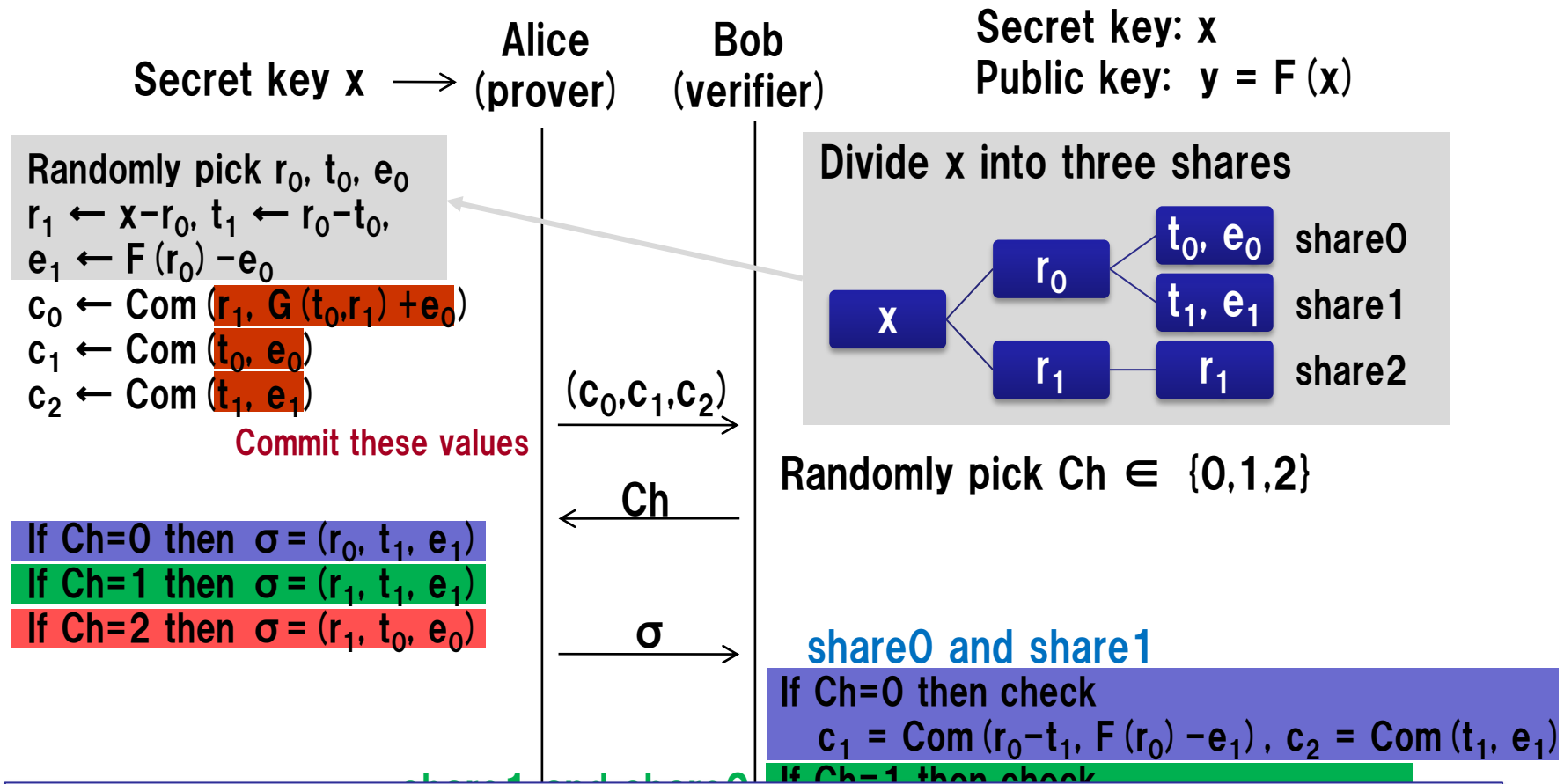

Theorem

- This protocol is statistically zero knowledge when Com is statistically hiding.
- This protocol is argument of knowledge for the MQ problem with knowledge error $2/3$ when Com is computationally binding.

Public-key identification schemes

Sequential Composition

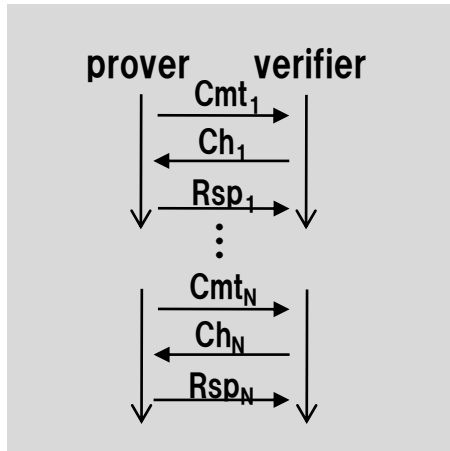

Parallel Composition

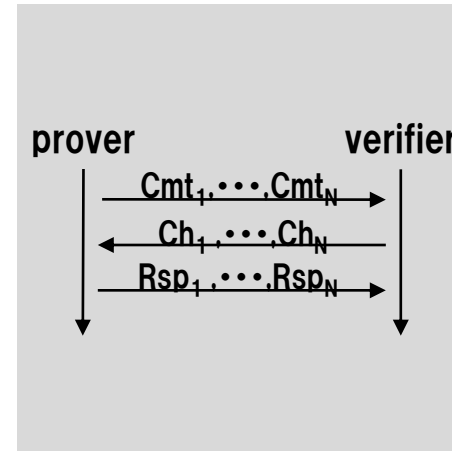

Achieve the security

against **active attack**

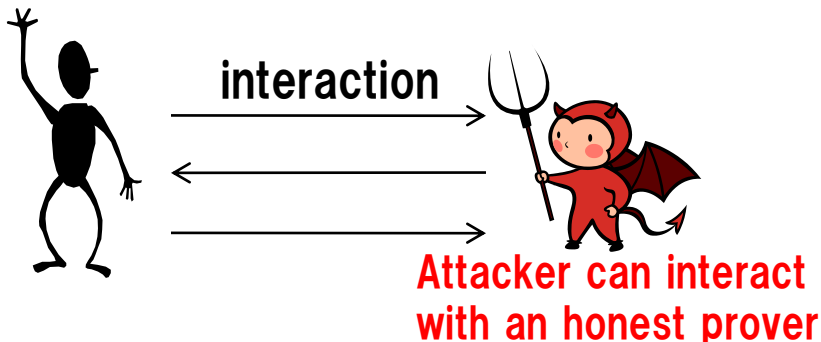

Achieve the security

against **passive attack**

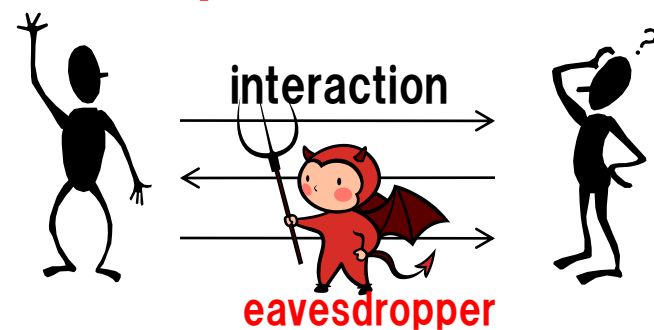

Public-key identification schemes

Sequential Composition

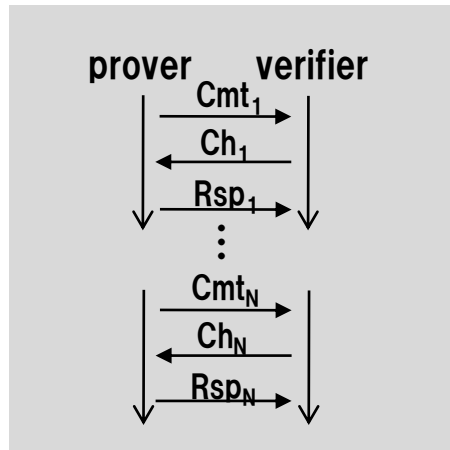

Parallel Composition

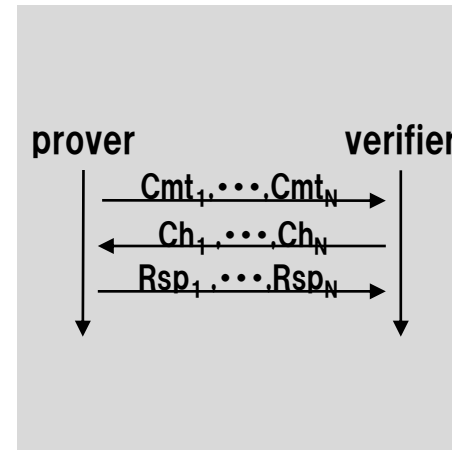

Achieve the security

against **active attack**

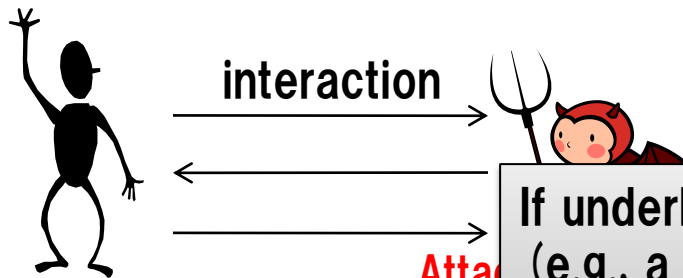

Attack with

Achieve the security

against **passive attack**



If underlying MQ function is substantially compressing (e.g., a map from 160 bits to 80 bits), the parallel version also achieves the security against **active attack**

Efficiency

- Comparison with public-key identification schemes based on another problem whose associated decisional version is NP-complete
 - The schemes from 3-pass zero knowledge argument of knowledge

Problem	SD [Stern '93]	CLE [Stern '94]	PP [Pointcheval '95]	MQ [Ours]
Public key size for 80-bit security	350 bit	288 bit	245 bit	80 bit
Communication data size	7.5 KByte	5.7 KByte	12.6 KByte	3.7 KByte
Arithmetic operations	$2^{24} / F_2$	$2^{16} / F_{257}$	$2^{22} / F_{127}$	$2^{26} / F_2$
Random permutation	S_{700}	S_{24}	S_{161}, S_{177}	Not required

- In the case that the protocol is repeated until the impersonation probability is less than 2^{-30} ($< 1/\text{one billion}$)

[Stern '93] "A New Identification Scheme Based on Syndrome Decoding", J. Stern.

[Stern '94] "Designing Identification Schemes with Keys of Short Size", J. Stern.

[Pointcheval '95] "New Identification Scheme Based on the Perceptrons Problem", D. Pointcheval.

Summary

- We proposed public-key identification schemes based on an MQ problem
 - **New design: different from existing MPKC**
 - Based on a zero knowledge argument of knowledge for the MQ problem
 - **Advantage: the security and the public key size**
 - The security can be reduced into the intractability of a random instance of MQ problem
 - The size of a public key is very small (e.g., 80 bits)
- Another application
 - Digital signature scheme

Thank you for your attention!